



liftinstituut  
SINCE 1933



# EU-TYPE EXAMINATION CERTIFICATE

Issued by Liftinstituut B.V.  
identification number Notified Body 0400,  
commissioned by Decision no. 2023-0000172941

Certificate no. : NL18-400-1002-187-15 Revision no.: 1

Description of the product : Energy dissipation type buffer

Trademark : Henning

Type no. : HPL 40 x 80

Name and address of the manufacturer : Henning GmbH & Co. KG  
Loher Strasse 4  
D-58332 Schwelm  
Germany

Name and address of the certificate holder : Henning GmbH & Co. KG  
Loher Strasse 4  
D-58332 Schwelm  
Germany

Certificate issued on the following requirements : Lifts Directive 2014/33/EU

Certificate based on the following standard : EN 81-20:2020, EN 81-50:2020 clause 5.5

Test laboratory : Liftinstituut, Alphen aan den Rijn

Date and number of the laboratory report : 18-01-2019, Test report belonging to the EU type-examination certificate nr.: NL18-400-1002-187-15

Date of EU-type examination : January 2024

Additional document with this certificate : Report belonging to the EU-type examination certificate no.: NL18-400-1002-187-15 rev.1

Additional remarks : Maximum nominal speed 1.0 m/s  
Load range 450 kg – 3500 kg

Conclusion : The safety component meets the requirements of the Lifts Directive 2014/33/EU considering any additional remarks mentioned above

Certification decision by

W.G. Kasteleijn  
Product Manager Certification

Amsterdam

Date : 17-01-2024

Valid until : 17-01-2029

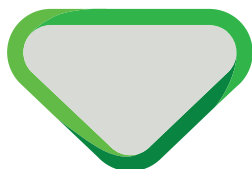

## Report EU-type examination

Report belonging to EU-type examination certificate number	: NL18-400-1002-187-15
Date of issue of original certificate	: 18-01-2019
Certificate applies to	: Safety component
Revision number / date	: 1 / 17-01-2024
Assessment basis	: Lifts Directive 2014/33/EU Standards: EN 81-20:2020 EN 81-50:2020 clause 5.5
Project number	: P200374

### 1. General specifications

Description of the product	: Energy dissipation type buffer
Trademark	: Henning
Type no.	: HPL 40 x 80
Name and address of the manufacturer	: Henning GmbH & Co. KG Loher Strasse 4 D-58332 Schwelm Germany
Laboratory	: Liftinstituut. Alphen aan den Rijn
Address of examined safety component	: -
Date of examination	: January 2024
Examination performed by	: Tolga Göktaş

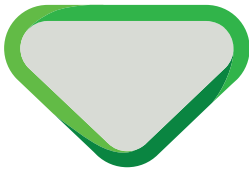

## 2. Description safety component

The HPL 40 x 80 is an energy dissipation type buffer or hydraulic buffer and is designed for lifts with a nominal speed up to 1.0 m/s. A contact is provided which checks if the plunger of the hydraulic buffer is in the extended position. The contact of the buffer is reset automatically.

### Specifications hydraulic buffer HPL 40 x 80

Total buffer height	305 mm
Diameter	115 mm
Buffer stroke	80 mm
Standard Oil (-10 °C .. +50 °C)	HLP ISO VG 46 DIN 51524-2
Oil for flame retardant and biodegradable applications (-10 °C .. +50°C)	Shell Naturelle HF-E 46
Low temperature oil (-20 °C .. +40 °C)	HVLP ISO VG 22 DIN 51524-3
Low temperature oil (-30 °C .. +40 °C)	MOBIL DTE 10 Excel 22

See annex 1 for a general overview of the product

## 3. Examinations and tests

The examination covered a check whether compliance with the Lifts Directive 2014/33/EU is met, if possible, based on the harmonized product standards EN 81-20:2020 and EN 81-50:2020 clause 5.5.

The examination included:

- Examination of the technical file (See annex 2):
- Check of performed calculations
- Examination of the representative model in order to establish conformity with the technical file.
- Inspections and tests to check compliance with the requirements.

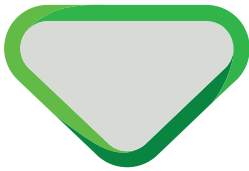

## 4. Results

After the final examination the product and the technical file were found in accordance with the requirements. The functional tests passed without remarks.

The load tests passed without remarks and did not lead to permanent deformations or loss of stability.

### 4.1 Calculations

The calculations were found accordance with the requirements.

### 4.2. Measurements

According to clause 5.5.3 of EN 81-50 the buffer was tested with the aid of weights, corresponding to the minimum and maximum masses, falling in free fall to reach at the moment of impact the maximum speed called for.

A description of the tests performed is given in “Test report belonging to EU-type examination nr.: NL18-400-1002-187-15”.

## 5. Conditions

Additional to or in deviation of the applicable demands in the considered requirements / standards (see certificate and/or page 1 of this report), the following conditions shall be taken into account:

- The energy dissipating (hydraulic) buffer is used only for lifts with nominal speed up to 1.0 m/s
- The maximum impact speed is 1.15 m/s
- A contact is provided to check if the buffer is in its extended position.
- The maintenance instructions for the user’s manual of the lift shall be provided with the lift.
- Load range is 450 – 3500 kg

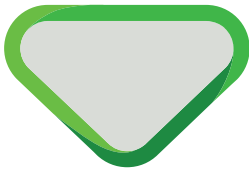

## 6. Conclusions

Based upon the results of EU-type examination Liftinstituut B.V. issues an EU-type examination certificate.

The EU-type examination certificate is only valid for products which are in conformity with the same specifications as the type certified product. The certificate is issued based on the requirements that are valid at the date of issue. In case of changes of the product specifications, changes in the requirements or changes in the state of the art the certificate holder shall request Liftinstituut B.V. to reconsider the validity of the certificate.

## 7. CE marking and EU Declaration of conformity

Every safety component that is placed on the market in complete conformity with the examined type must be provided with a CE marking according to article 18 of the Lifts Directive 2014/33/EU under consideration that conformity with eventually other applicable Directives is proven. Also every safety component must be accompanied by an EU declaration of conformity according to annex II of the Directive in which the name, address and Notified Body identification number of Liftinstituut B.V. must be included as well as the number of the EU-type examination certificate.

An EU type-certified safety component shall be random checked e.g. according to annex IX of the Lifts Directive 2014/33/EU before these safety components may be CE-marked and may be placed on the market. For further information see regulation 2.0.1 'Regulations for product certification' on [www.liftinstituut.com](http://www.liftinstituut.com).

Prepared by:

Tolga Göktaş  
Product Specialist Certification

Certification decision by:

W.G. Kasteleijn  
Product Manager Certification

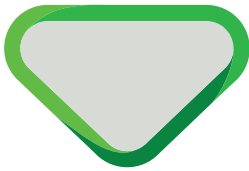

# Annexes

## Annex 1. General overview of the product

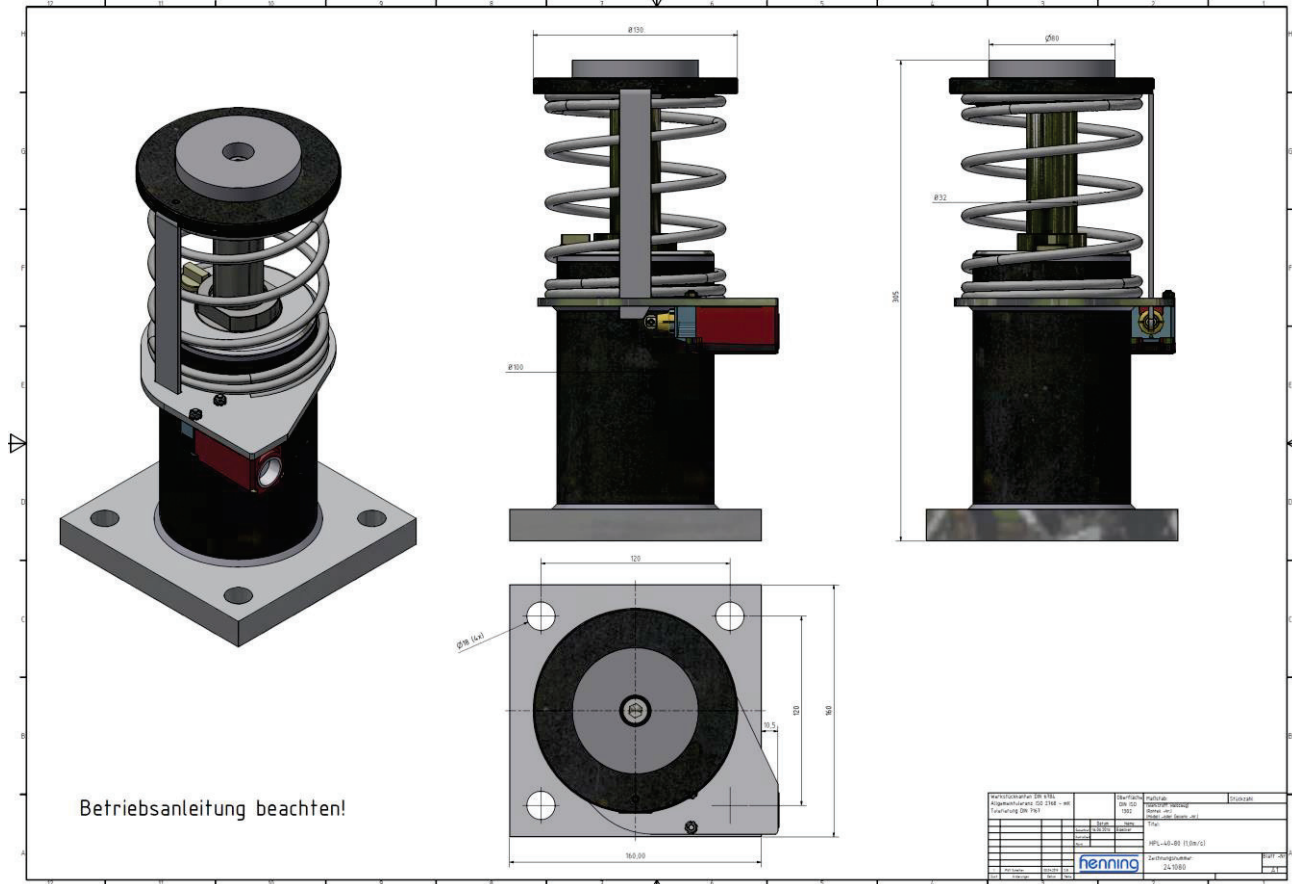

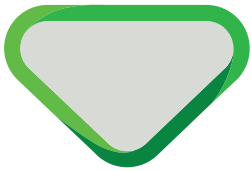

Annex 2. Documents of the Technical File which were subject of the examination

Title	Document number	Date
Shell Naturelle HF-E 46	v 4	20-09-2013
Ölempfehlung für Liftpuffer LP und Schrägaufzugspuffer HSAP	-	03-04-2017
Berechnungen zur Baumusterprüfung für Aufzugspuffer HPL 40 x 80 bis HPM 40 x 430	-	14-12-2018
Drawing HPL 40 x 80	241080	16-08-2018
Drawing pipe HPL 40 x 80	97401130	29-10-2018
Liftpuffer LP / HPL / HPM & HSAP	V 1.1.0	08-07-2020
GL-XX-Mobil-DTE-10-Excel-Series	Mobil DTE 10 Excel™ Reihe	08-07-2020
Betriebsanleitung für Liftpuffer HPL & HPM	Version 1.0.2	08-01-2021

Annex 3. Reviewed deviations from the standards

EN xx-x par.	Requirement	Accepted design
x.x.x		

Annex 4. Revision of the certificate and its report

Rev.:	Date	Summary of revision
-	18-01-2019	Original
1	17-01-2024	- Re-certification for another 5 years - Updated Annex 1 - Upgraded to EN 81-20:2020 and EN 81-50:2020 - Added Shell and MOBIL oil

--- End of report ---

## EU-declaration of conformity

We

**Henning GmbH & Co. KG**  
**Loher Str. 4**  
**58332 Schwelm**

hereby declare, that the following designated products, because of their conception, design and prototype test, do meet the relevant health and safety requirements of the EU directive.  
 This declaration loses its validity if the product has been subjected to any unauthorized alterations.

Product:	Lift buffer, model LP	EU TYPE-EXAMINATION CERTIFICATE Notified Body	
HPL 40 x 80	Year of construction	see type label	NL18-400-1002-187-15 Rev.1
	Series No.:	see marking on buffer	Code 0400
HPL 40 x 120	Year of construction	see type label	NL18-400-1002-187-16 Rev.1
	Series No.:	see marking on buffer	Code 0400
HPL 40 x 175	Year of construction	see type label	NL18-400-1002-187-17 Rev.1
	Series No.:	see marking on buffer	Code 0400
HPM 40 x 275	Year of construction	see type label	NL18-400-1002-187-18 Rev.1
	Series No.:	see marking on buffer	Code 0400
HPM 40 x 430	Year of construction	see type label	NL19-400-1002-187-19 Rev.0
	Series No.:	see marking on buffer	Code 0400

The EU type-examination according to **Annex IV (module B)** of directive **2014/33/EU** and the **random sample check** according to **Annex IX (module C2)** of directive **2014/33/EU** for hydraulic lift buffers has been carried out by Liftinstituut B.V., Buikslotermeerplein 381, P.O. Box 36027, 1025 XE Amsterdam. **Code 0400**

**Relevant EU-Directives:**  
**EU Lifts Directive 2014/33/EU**

**Applied harmonized standards:**  
**EN 81-20:2020, EN 81-50:2020 5.5**  
 Safety rules for the construction and installation of lifts

Schwelm, 18/01/2024



Henning GmbH & Co. KG  
 (Philip Molineus, Geschäftsführer)